

COMPARISON OF MECHANICAL SUPPRESSION BY SHOT PEENING AND LOW PLASTICITY BURNISHING TO MITIGATE SCC AND CORROSION FATIGUE FAILURES IN 300M LANDING GEAR STEEL

N. Jayaraman and P. Prevéy
Lambda Research, 5521, Fair Lane, Cincinnati, OH 45227-3401

Neal Ontko, Michael Shepard, Robert Ware and Jack Coate
Air Force Research Laboratory, MLSC, 2179 12th Street, WPAFB, OH 45433

ABSTRACT

300M steel is widely used in aircraft landing gear because of its unique combination of strength and fracture toughness, but is vulnerable to foreign object damage (FOD), corrosion fatigue, and stress corrosion cracking (SCC) failures with potentially catastrophic consequences. The fatigue, corrosion fatigue in salt water, and SCC performance of LPB processed 300M steel was compared with shot peened (SP) and low stress ground (LSG) conditions. LPB, with and without simulated FOD, produced deep residual compression that dramatically improved both the HCF and corrosion fatigue strength. The fatigue strength of LSG and SP treated surfaces was drastically reduced by salt and FOD exposure with no discernible endurance limit for corrosion fatigue conditions. SCC testing of LPB treated landing gear sections at 1030 to 2270 MPa (150 to 180 ksi) static loads was terminated after 1500 hrs without failure, compared to failure in as little as 13 hours without treatment. Mechanistically, the deep compressive surface residual stresses from LPB treatment mitigated both the individual and synergistic effects of corrosion fatigue and FOD. LPB also reduced the surface stress well below the SCC threshold for 300M, even under high tensile applied stresses, effectively suppressing the SCC failure mechanism.

INTRODUCTION

SCC, corrosion fatigue, and FOD are generally recognized as significant degradation processes that affect aircraft landing gear components.¹ The phenomenon of SCC is generally understood to be the result of a combination of susceptible material, corrosive environment, and tensile stress above a threshold (Figure 1). Conventional SCC mitigation includes modifying the material (alloy chemistry) or the use of protective coatings to eliminate contact with the corrosive environment. A novel approach of “mechanical suppression” of SCC and corrosion fatigue by introducing deep surface residual compressive stresses by LPB²⁻⁵ is presented in this paper. LPB can be performed on CNC machine tools at costs and speeds comparable to conventional machining operations such as surface milling.

EXPERIMENTAL PROCEDURE

SPECIMEN PREPARATION AND PROCESSING

300M steel was procured in the form of ~12.7 mm (0.5 in.) thick plates. Thick section bending fatigue specimens²⁻⁵ (Figure 2) were machined and heat-treated. The tensile properties of the heat-treated

steel are as follows: 0.2% Y.S. = 1,690 MPa (245 ksi), UTS = 2,000 MPa (290 ksi), Elong. = 10%, RA = 35%, Hardness = 55 HRC.

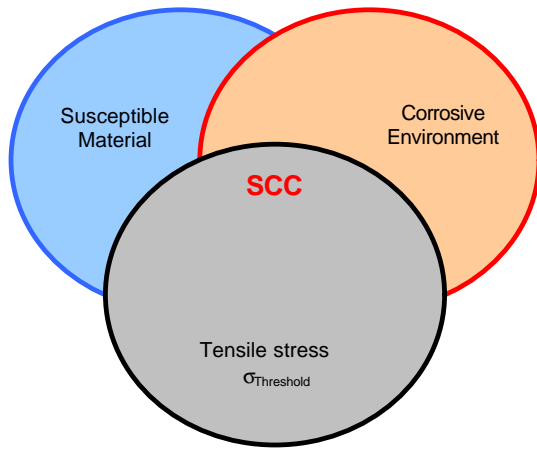

Figure 1 - SCC susceptibility diagram

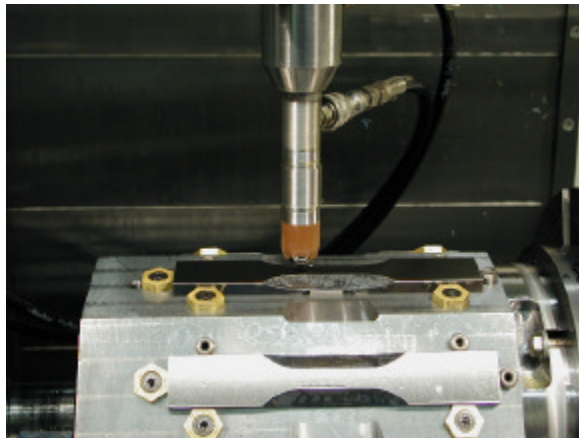

Figure 2 - A set of 8 thick section specimens being LPB processed in a 4-axis CNC milling machine.

Surface Enhancement Technologies, LLC. (SET) developed the LPB process parameters for thick sections of 300M steel using proprietary methods. The CNC control code was modified to allow positioning of the LPB tool in a series of passes along the

gage section (Figure 2) while controlling the burnishing pressure to develop the desired magnitude of compressive stress with relatively low cold working. Shot peening was performed using CCW14 shot for 150% coverage at 8A and 10A intensities. Residual stresses were measured using a conventional x-ray diffraction ($\text{Sin}^2\theta$) method on all surface treated specimens, before and after exposure to 400°F for 48 hours, which simulates the hydrogen bake-out treatment following cadmium or chromium plating.

FATIGUE AND STRESS CORROSION CRACKING TESTS

HCF tests were performed under constant amplitude loading on a Sonntag SF-1U fatigue machine, with ambient temperature (~72F) in four-point bending mode, at a stress ratio, $R = \sigma_{\min}/\sigma_{\max} = 0.1$, and cyclic frequency of 30 Hz. FOD was simulated with a semi-elliptical surface EDM notch (Figure 3) introduced into the center of the gage section. Corrosion fatigue testing was performed in neutral 3.5% NaCl salt solution made with de-ionized water. Filter papers were soaked with the salt solution, wrapped around the gage section of the fatigue test specimen (Figure 4), and sealed with tape and a plastic film to avoid evaporation. The salt solution contacted the sample surface for only moments before the initiation of cyclic loading. The following is a list of test conditions used in this study:

	Baseline (LSG)	Shot Peened	LPB Treated
Base (No FOD, No Salt)	✓	✓	✓
Salt Exposure	✓	✓	✓
Simulated FOD	✓	✓	✓
Simulated FOD + Salt Exposure	✓	✓	✓

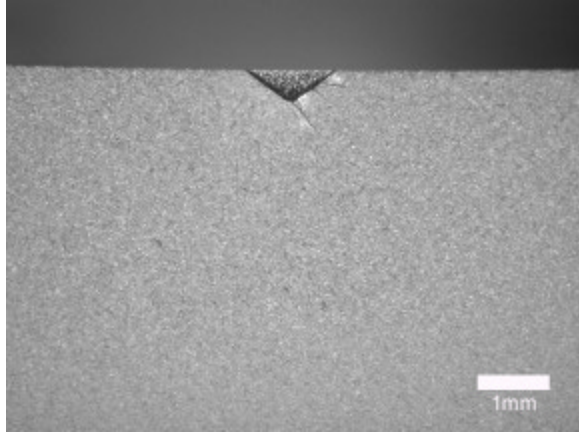

FIGURE 3 - Cross-section of 0.5 mm deep EDM notch to simulate FOD.

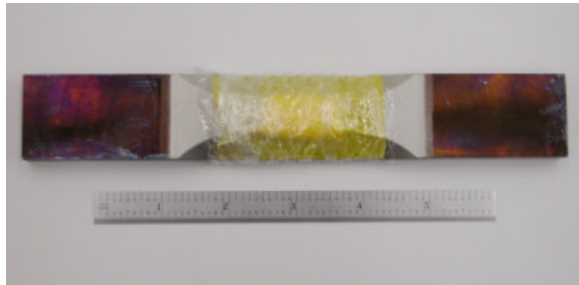

FIGURE 4 - A thick section specimen with salt solution soaked tissue wrapped around the gage section.

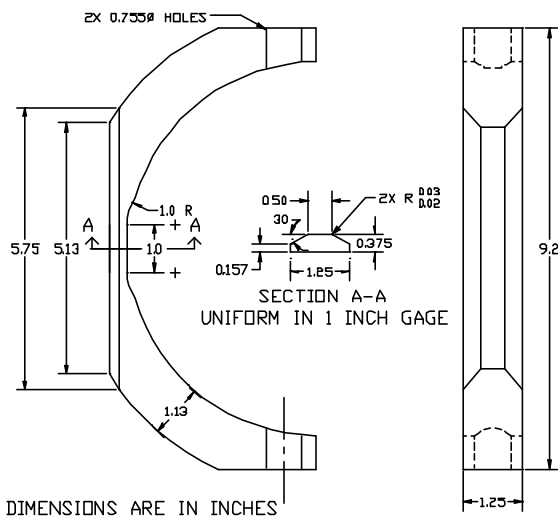

Figure 5 - C-ring specimen.

SCC tests were performed on C-ring specimens (Figure 5) machined from an actual 300M steel landing gear. The gage region of the C-ring specimen had a cross section similar to the bending fatigue specimens shown in Figure 2. The specimen is loaded with a bolt through the 19 mm (0.75 in.) hole, placing the outer surface in nominally uniform tension over the 25 mm (1 in.) long parallel gage section. Both untreated and LPB treated samples were SCC tested at 1033, 1137 and 1240 MPa (150, 165 and 180 ksi) static loads in alternate immersion (10 min. wet, 50 min. dry) in neutral 3.5% NaCl. The load was monitored as a function of time, with time to failure noted.

RESIDUAL STRESS DISTRIBUTIONS

The residual stress distributions measured as functions of depth are presented graphically in Figures 6 and 7. Compressive stresses are shown as negative values and tensile stresses as positive. Compared to SP, LPB produced compressive residual stresses of greater magnitude, nominally – 1033 MPa (-150 ksi) for SP vs. -1240 MPa (-180 ksi) for LPB, and an order of magnitude greater depth. Thermal exposure to 400°F for 48 hours, simulating baking after electroplating, did not result in significant relaxation of either SP or LPB compression.

HCF AND CORROSION FATIGUE PERFORMANCE

The HCF and corrosion fatigue performance of 300M steel is shown in Figures 8-11 as maximum stress S-N curves. Figure 8 shows the baseline material performance with and without the EDM notch and salt exposure. The unnotched baseline fatigue strength (endurance limit at 10^7 cycles) is nominally 1035 MPa (150 ksi). In the presence of a neutral salt solution, the baseline corrosion fatigue strength drops dramatically to about 205 MPa (30 ksi) with

loss of endurance limit behavior. Introduction of an EDM notch drastically decreases the fatigue strength to nominally 140 MPa (30 ksi) for air and to less than 70 MPa (10 ksi) in the salt environment. Power law lines were fitted to the data in Figure 8, representing the average behavior of the

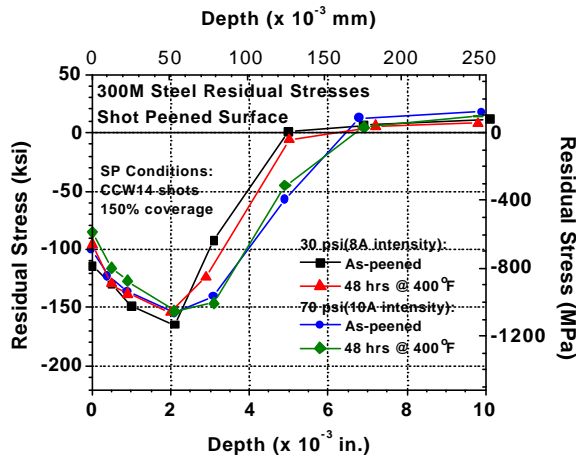

Figure 6 – SP subsurface residual stress distributions.

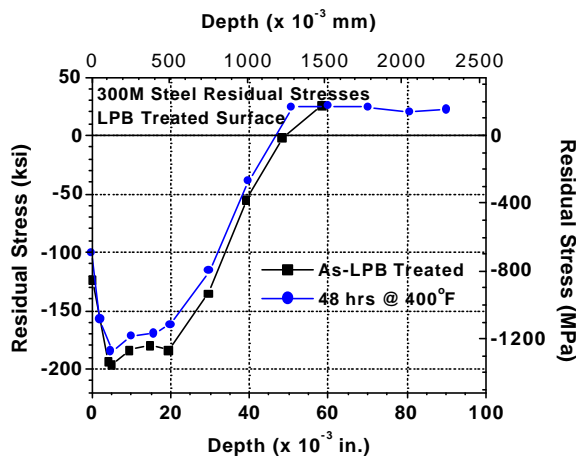

Figure 7 – LPB subsurface residual stress distributions.

material in its baseline condition. The HCF and corrosion fatigue performance of both unnotched and notched SP treated specimens is shown in Figure 9. Benefits of surface compression from the SP treatment are clearly seen as improved HCF

performance of the unnotched specimens. The corrosion fatigue strength in neutral salt is reduced to nominally 515 MPa (75 ksi), again with loss of endurance limit behavior. FOD 0.5 mm deep penetrates the SP layer and reduces the strength to that of the notched baseline condition in both air and neutral salt. Figure 10 shows the HCF and corrosion fatigue behavior of LPB treated specimens. The unnotched specimen shows superior HCF performance with a fatigue strength of 1200 MPa (175 ksi). Here, notched HCF and both notched and unnotched corrosion fatigue test results may all be grouped into one set of data at slightly lower fatigue strength of 1000 MPa (145 ksi), with the endurance limit behavior restored. Three conclusions may be reached from the fatigue data. First, the LPB process has effectively mitigated corrosion fatigue of 300M steel in salt water. Second, the HCF and corrosion fatigue performance of LPB treated 300M with either 0.5 mm FOD or salt-water exposure is statistically similar to the unnotched baseline material. Third, when tested in the neutral salt solution environment, the endurance limit behavior that was absent in both baseline and SP treatment is restored with the LPB treatment. These same results are summarized in the chart shown in Figure 11.

In Figure 12 the SCC test results show the untreated baseline material had SCC time to failure of 261.8 hrs at 1034 MPa (150 ksi), 166.5 hrs at 1138 MPa (165 ksi) and 12.9 hrs at 1241 MPa (180 ksi), respectively. The LPB treated specimens did not fail even after 1500 hrs of exposure at all the three stress levels. When the specimens were loaded to higher stress levels, instead of cracking, the specimens were severely bent at higher loads. These results indicate the deep surface compressive stresses from LPB fully mitigated SCC as a failure mechanism.

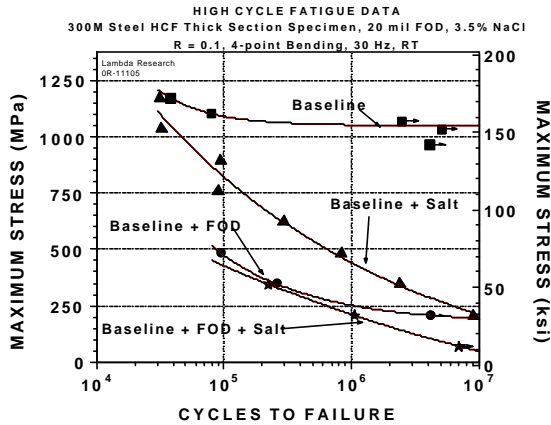

Figure 8 - Baseline fatigue results.

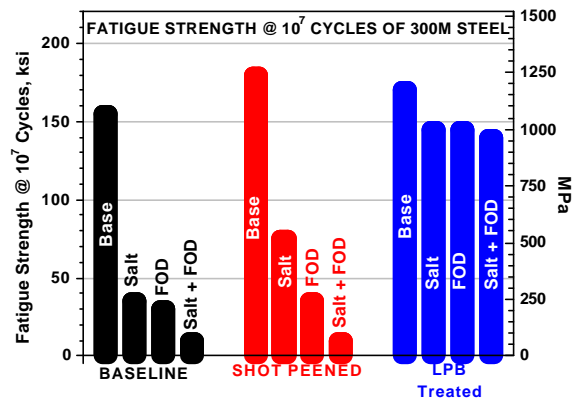

Figure 11 - Summary of fatigue results.

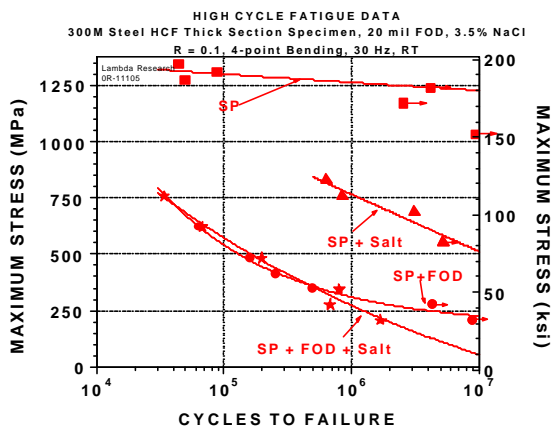

Figure 9 - Fatigue results for SP.

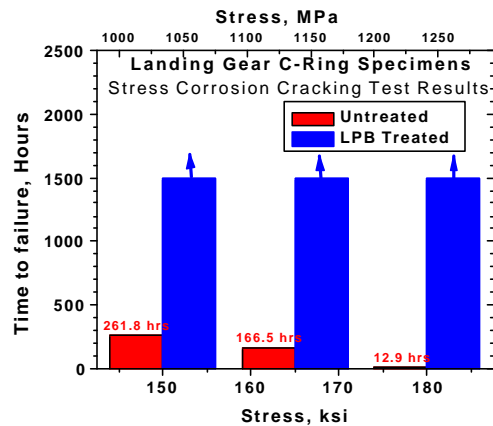

Figure 12 - SCC test results.

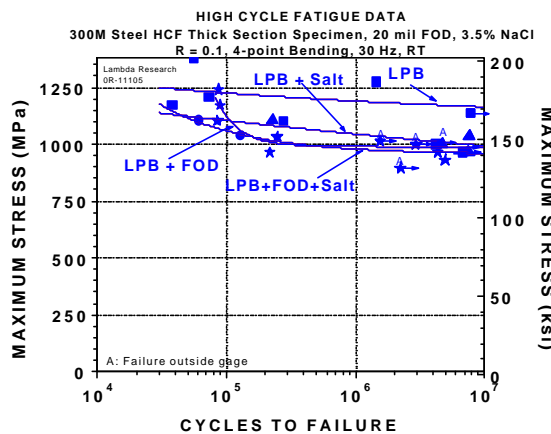

Figure 10 - Fatigue results for LPB

Fractographic analyses of the notched and other HCF test conditions yielded results that are expected and consistent with the fatigue test results shown in Figures 8-11. In baseline and SP conditions, the corrosion fatigue failure mechanism involved single or multiple crack initiation from shallow corrosion pits, whereas subsurface crack initiation (not from corrosion pits) was evident for the LPB condition. In all cases, some pitting of the gage surface was evident, and the cross-sectional views indicated a gradual increase in the depth of corrosion pitting damage with increased time of testing.

SUMMARY AND CONCLUSIONS

The fatigue, salt-water corrosion fatigue, and FOD tolerance of LPB, shot peened and baseline 300M steel was compared. LPB provided a compressive layer an order of magnitude deeper and more compressive than 8-10A shot peening. LPB completely mitigated the fatigue debits from both 0.5 mm deep FOD and salt-water exposure, providing fatigue strength and life comparable to undamaged baseline material. Shot peening provided only half of the salt-water corrosion fatigue strength of LPB. The results overwhelmingly indicate that the deep surface compression from LPB completely mitigated alternate immersion salt water SCC under static stress up to the yield strength of the alloy.

ACKNOWLEDGEMENTS

Support of this work with IR&D funding from Lambda Research and SCC testing provided by the Air Force Materials Lab is gratefully acknowledged. The authors also wish to thank Doug Hornbach for residual stress measurements; Perry Mason and David Wright for conducting fatigue tests, and Brian Tent for SEM analysis.

REFERENCES

1. E. U. Lee, (1995), Metall. Mater. Trans. A, 26A, (5); May, pp. 1313-1316.
2. P. Prev y, N. Jayaraman, R. Ravindranath, (2003), "Effect of Surface Treatments on HCF Performance and FOD Tolerance of a Ti-6Al-4V Vane," Proc. 8th National Turbine Engine HCF Conference, Monterey, CA, April 14-16.
3. M. Shepard, P. Prev y, N. Jayaraman, (2003), "Effect of Surface Treatments on Fretting Fatigue Performance of Ti-6Al-4V," Proc. 8th National Turbine Engine HCF Conference, Monterey, CA, April 14-16.
4. J. Cammett and P. Prev y, (2003), "Fatigue Strength Restoration in Corrosion Pitted 4340 Alloy Steel Via Low Plasticity Burnishing." Retrieved from www.lambda-research.com
5. P. Prev y, (2000), "Low Cost Corrosion Damage Mitigation and Improved Fatigue Performance of Low Plasticity Burnished 7075-T6," Proc. of the 4th International Aircraft Corrosion Workshop, Solomons, MD, Aug. 22-25.
6. N. Jayaraman, P. Prev y, M. Mahoney, (2003), "Fatigue Life Improvement of an Aluminum Alloy FSW with Low Plasticity Burnishing," Proc. 132nd TMS Annual Meeting, San Diego, CA, Mar. 2-6, 2003.